

AR30 Assistrail

Public Access Handrail Specifications

Single Inline Handrail / Midrail

For stairs and level applications under one metre (FFL) & midrail for extra protection



AR30

Key features

- > Modular flexibility
- > No-weld assembly
- > Flat pack delivery
- > Reduced corrosion
- > Colour options
- > Available ex-stock
- > BIM & CAD Support

Applications suited to

- > DDA access ramps and stairs
- > Fire and access stairs
- > Aged care and accommodation
- > Hospitals, schools, universities
- > Public transport and sightseeing
- > Community and recreation centres

Specification Summary

Supply and install the proprietary AR30 handrail system to substrate according to Moddex specifications, or by a Moddex accredited installer.

Technical Data

Material

Stanchions & rails	Steel/grade C250 & 350
Clamp fittings	Malleable Cast iron
Clamp locking screws	Stainless Steel (304)

Protective coating

Stanchions & rails	G390 Hot Dip Galvanized (min 390g/m ²)
Clamp fittings	Hot-dip Galvanized with patented protective coating on threads
Optional	Powder coating and paint specs*

*The standard process for Powder Coated and Painted handrail products is as follows: black steel is used for fabrication and then hot-dipped galvanized. Product is then de-gassed and pre-treated before powder coating is applied on top of galvanising.

Dimensions

Variable depending on building/application/code

Stanchions

Diameter	48.3mm OD 41.9mm ID
Nominal Thickness	3.2mm - 4.0mm (loading dependent)

Rails

Diameter	48.3mm OD 41.9mm ID
Nominal Thickness	3.2mm

Clamp fittings

Thickness	5.0mm (approx)
Locking screws	M12 x 1.75 x 11mm - DEXX [®] Drive

Weight

Variable depending on building/application/code

Stanchion with clamps	7.2 to 8.0kg
Rail @ 6.0m	21.6kg

Fixings

Stanchion attachment to

Concrete	M12 galvanized mechanical concrete anchor
Structural steel	M16 galvanized high tensile bolt set

*Other Fixing options are available on request

Compliance

Moddex AR30 handrails are designed and manufactured in accordance with the New Zealand Building Code D1 Access Routes and NZS 4121:2001. Galvanized to AS 4792 and AS/NZS 4680:2006 (where applicable).

Testing

Testing and performance based on requirement of Australian & New Zealand Standard AS1170.1 Clause 3.6 Table 3.3. Stringent vibration endurance tests have been performed.

Warranty

5 years from date of purchase subject to correct installation, use and maintenance in accordance with manufacturer's specifications and recommendations, unless otherwise negotiated at the time of purchase.

— Refer maintenance manual

Inspection & Maintenance

Visual inspection for any damage or loose fixings must be done periodically and prior to use. No certified maintenance required. Basic wear and tear preventative maintenance is recommended, as per manufacturer's specifications and recommendations.

— Refer maintenance manual

Basis of Design

When designed as per the Moddex PS1

1. Design Life: 50 years minimum
2. Building Occupancy: B, E
3. Loading: AS/NZS 1170.1:2002 - TABLE 3.3 AS 1657: 2013 CL6.1
4. Live Loading: Line: 0.35kN/m
Concentrated: 0.6kN
Infill: N/A

BPIR

BPIR, set new minimum requirements for the level of information required about building products supplied to the New Zealand market. Moddex is committed to meeting these requirements - download the latest information here:

<https://moddex.com/resources/downloads/#bpir-sheets>

Technical Information

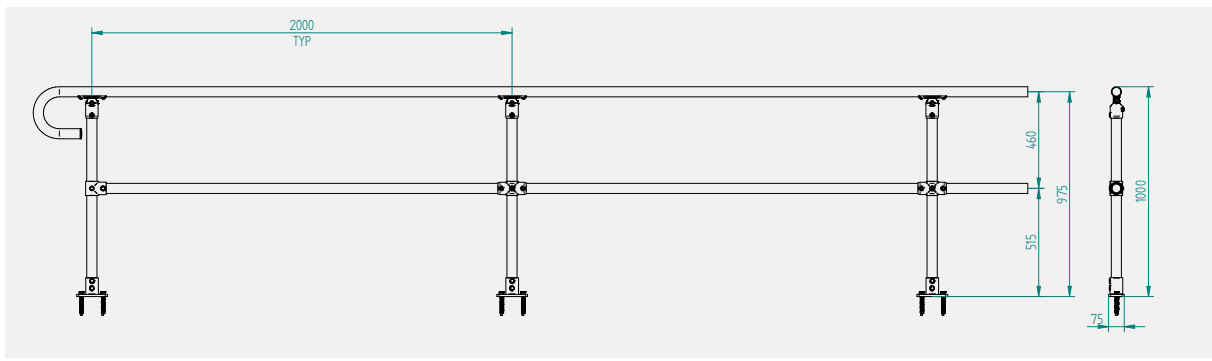

Mount Dimensions

FIXING TO CONCRETE

T2 - Top Mount (2 Fixings)

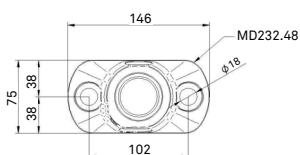

F2 - Face Mount (2 Fixings)

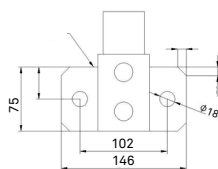
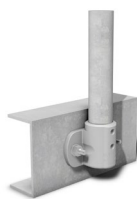

CD - Cored Mount

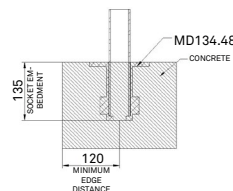

T4 - Top Mount (4 Fixings)

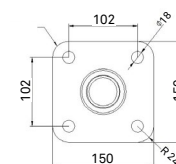

FIXING TO STEEL

T2 - Top Mount (2 Fixings)

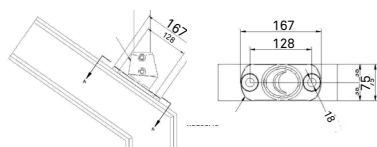

F2 - Face Mount (2 Fixings)

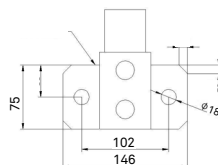

T4 - Top Mount (4 Fixings)

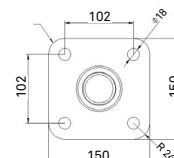

FIXING TO TIMBER

T4 - Top Mount (4 Fixings)

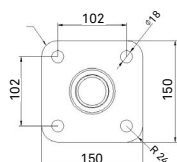

F4 - Face Mount (4 Fixings)

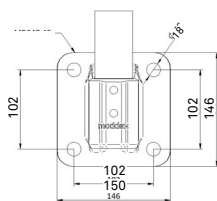

Standard References

New Zealand Building Code

- As noted in NZBC Clause D1 Access Routes, handrails shall be provided on both sides of accessible stairways and accessible ramps.

New Zealand Standard 4121:2001

- 8.3 Stair Design
- Figure 22
- Figure 23
- 8.6

[DOWNLOAD OUR GUIDE TO HANDRAIL & BALUSTRADE COMPLIANCE HERE](#)

Important Note: Failure to supply and/or install proprietary product in accordance with above Standards and codes, specification and instructions, voids complete system certification and/or warranty.

Designed and manufactured by Moddex Systems. ©Moddex Group. All Rights Reserved.

For information or technical support please contact us

- T 1800 663 339 (AU)
- T 0800 663 339 (NZ)

moddex.com